

Table of Contents

- Understanding Wiegand 1
- What is Wiegand? 1
- Wiegand Signal 1
- Parity Bit 2
- Wiegand Format 2
- Suprema Device and Wiegand 2
- Wiegand Input and Output 3
- Wiegand Mode 3
- Customize Wiegand Format 4
- Frequently Asked Questions 8
- Summary 8
- Appendix 1. Wiegand 34bit Mifare Card Format Setting Example 9
- Appendix 2. Wiegand Format Template 10

BioStar 1, Wiegand

Understanding Wiegand

This document provides additional information to help you understand the Wiegand and Wiegand interface. Please note that this document applies to BioStar version lower than 1.7.

What is Wiegand?

Wiegand is the most common communication method used by access control devices. The term Wiegand in BioStar is a communication protocol that connects Suprema device and 3rd party device to send ID data or connects Suprema device with RF reader to send ID data.

Wiegand Signal

The Wiegand interface consists of three conductors (wires) called Data Zero (Green), Data One (White), and Ground (Black). When no data is being sent, both DATA0 and DATA1 are pulled up to the "high" voltage level — usually +5 VDC. For detailed Wiegand Data Cable diagram, please refer to Suprema device manual.

[Figure 1 Wiegand Data Cable for BioEntry Plus]

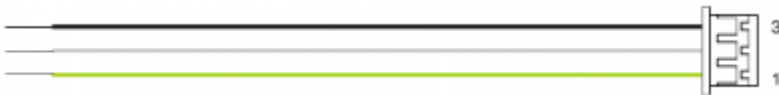

When a 0 is sent the DATA0 wire is pulled to a low voltage while the DATA1 wire stays at a high voltage. When a 1 is sent the DATA1 wire is pulled to a low voltage while DATA0 stays at a high voltage.

[Figure 2 Data 0 and Data1 structure (For binary data 11010)]

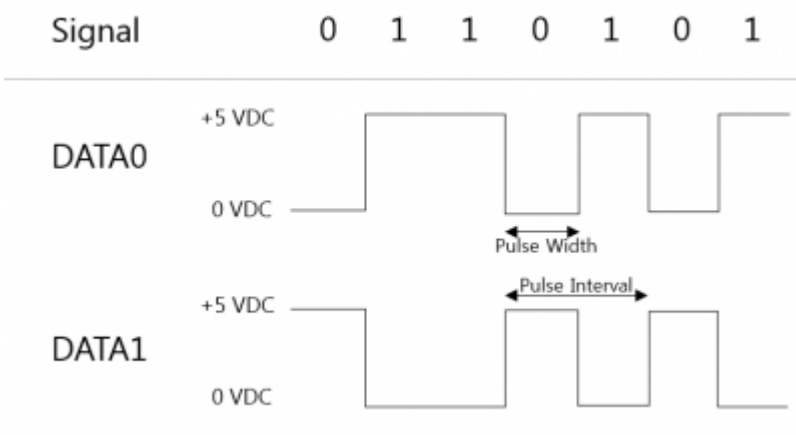

Pulse width and pulse intervals for Suprema devices

Editable

- BST/BST2/FST/DST: Pulse Width 40 , Pulse interval 10,000

Non-editable

- BEPL/BLN/XPASS: Pulse Width 50 , Pulse interval 2000

Parity Bit

A parity bit is used as a simple quality check for the accuracy of the transmitted binary data. Each parity bit should be set to even or odd. A selected group of data bits will be united with one parity bit, and the total number of bits should result in either an even or odd number.

Wiegand Format

BioStar supports default 26bit Standard Wiegand Format, Pass Through Wiegand Format and Custom Wiegand Format.

[Figure 3 Wiegand Format Configuration]

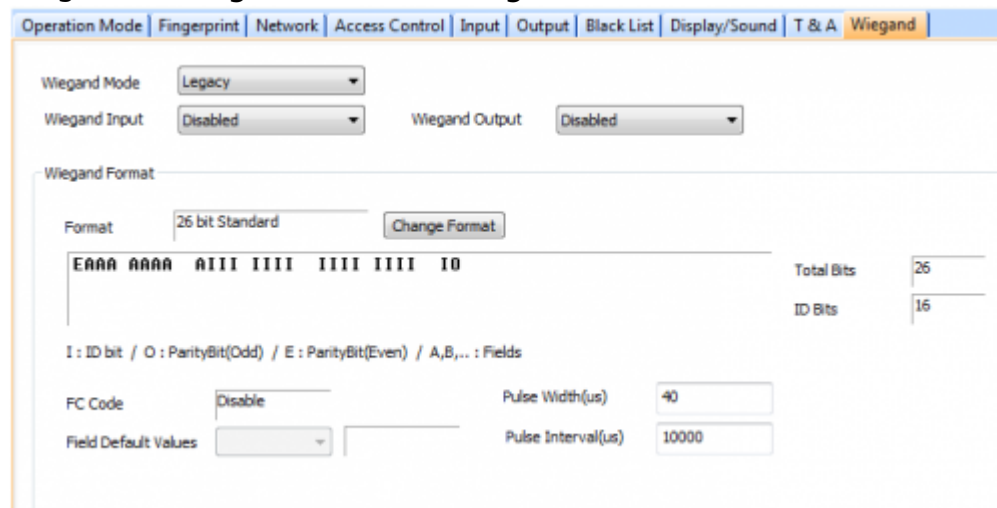

Suprema Device and Wiegand

In BioStar, you need to set the Wiegand mode; accept Wiegand signal as Wiegand input for further processing within the device or send Wiegand signal created from the device as Wiegand output to 3rd party device. The Wiegand data is transferred to selected direction. BioStar allows for both Wiegand Input and Output mode. BioStar activates door relay after receiving Wiegand signal and authentication is success, alternatively, BioStar sends Wiegand signal to 3rd party controller.

Wiegand Input and Output

A card reader using Wiegand can pass the User ID or Card ID to the BioStar for verification.

[Figure 4 BioStation used as Wiegand Input]

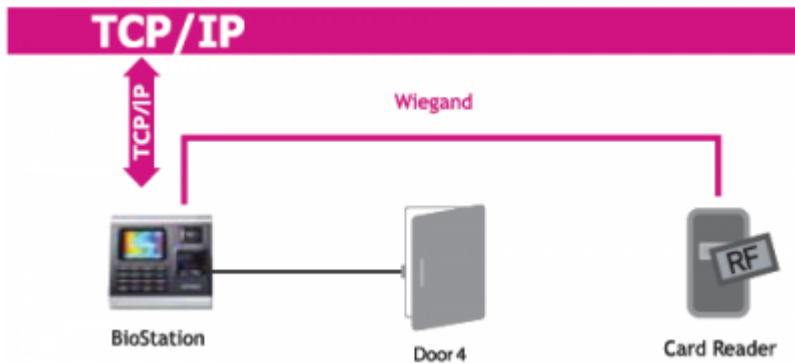

Suprema device can pass the User ID or Card ID to the 3rd party controller for verification and 3rd party controller opens the doors based on the information received from Suprema device.

Wiegand Mode

Wiegand input/output mode to use when reading card ID data.

BioStar have following Wiegand modes:

- Legacy: RF Reader will be treated as part of their host device.
- Extended: RF Reader will be treated as independent device. The extended mode assigns RF reader a separate ID which allows them to be associated with doors, included in zones, and leave logs.

[Figure 5 Wiegand Format Configuration - 1]

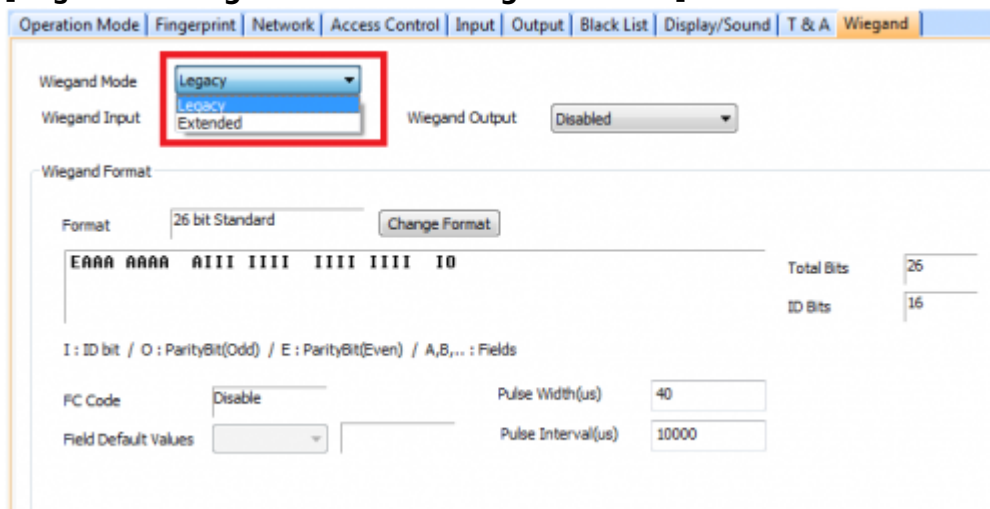

Customize Wiegand Format

37 Bit Wiegand HID H10304 Card Format Card Layout Tab

Card Format Name: 37 Bit Wiegand HID H10304

Card Type: Wiegand

Number of bits: 37

Number of bits to sum for even parity: 19

Address to start from: 0

Number of bits to sum for odd parity: 19

Address to start from: 18

Number of Facility Code bits (Undefined): 16

Address to start from: 1

Number of Cardholder ID bits: 19

Address to start from: 17

Number of Issue Level bits: 0

Address to start from: 0

Facility Code

Facility Code: 001

1. Go to **BioStar Client > Device > Wiegand** tab.
2. According to the card format above, total number of bits is 37. In this case, click **Change Format** button to set customized Wiegand format.

[Figure 6 Wiegand Format Configuration - 2]

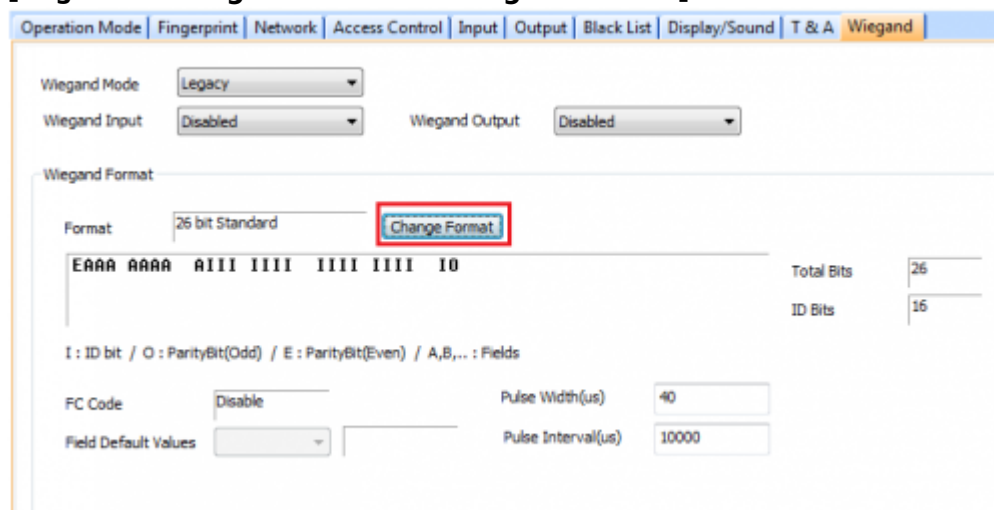

3. Click **Custom Wiegand Format**.

[Figure 7 Wiegand Format Configuration - 3]

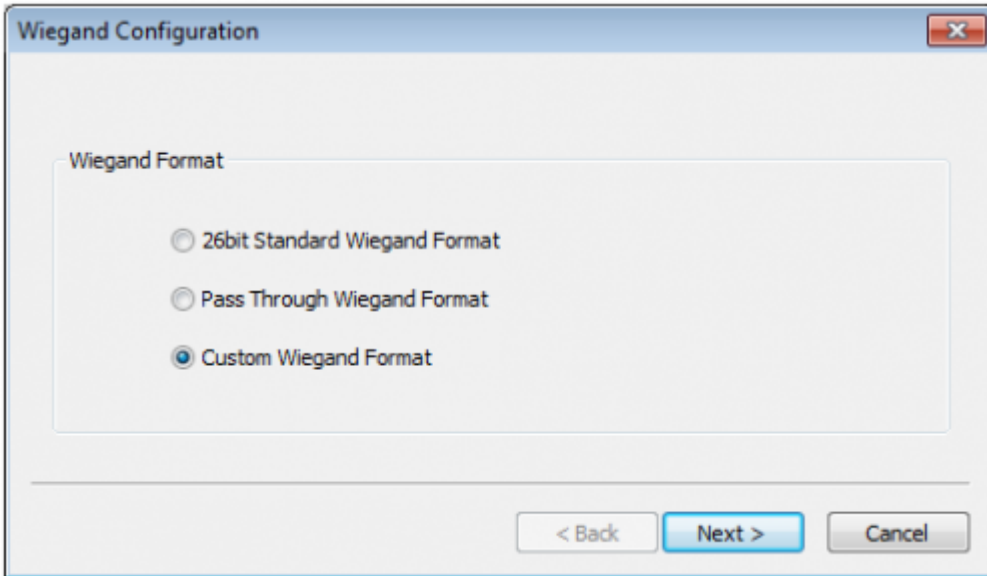

4. Change the **Total Bits** and click **Apply**.

[Figure 8 Wiegand Format Configuration - 4]

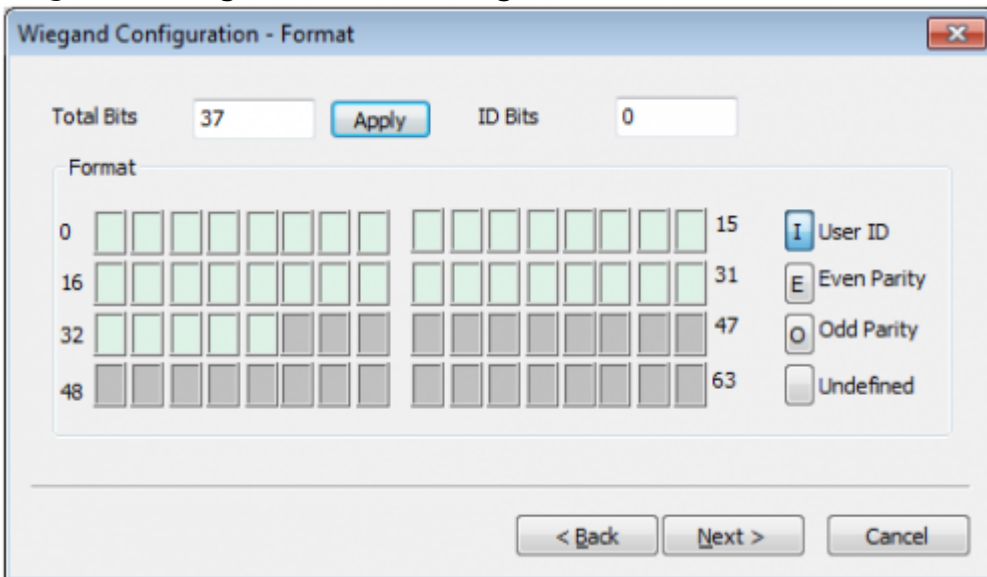

5. Set Even Parity, Odd Parity, User ID bits by clicking the blocks. (Facility cod bits are not editable as they are undefined. Mark [E] at the starting bit and mark [O] at the ending bit.)

Number of bits: 37
Number of bits to sum for even parity: 19 (Address to start from: 0)
Number of bits to sum for odd parity: 19 (Address to start from: 18) (Address to end : 37)
Number of Facility Code bits (Undefined): 16 (Address to start from: 1)
Number of Cardholder ID bits: 19 (Address to start from: 17)
Number of Issue Level bits: 0 (Address to start from: 0)
Facility Code: 001

[Figure 9 Wiegand Format Configuration - 5]

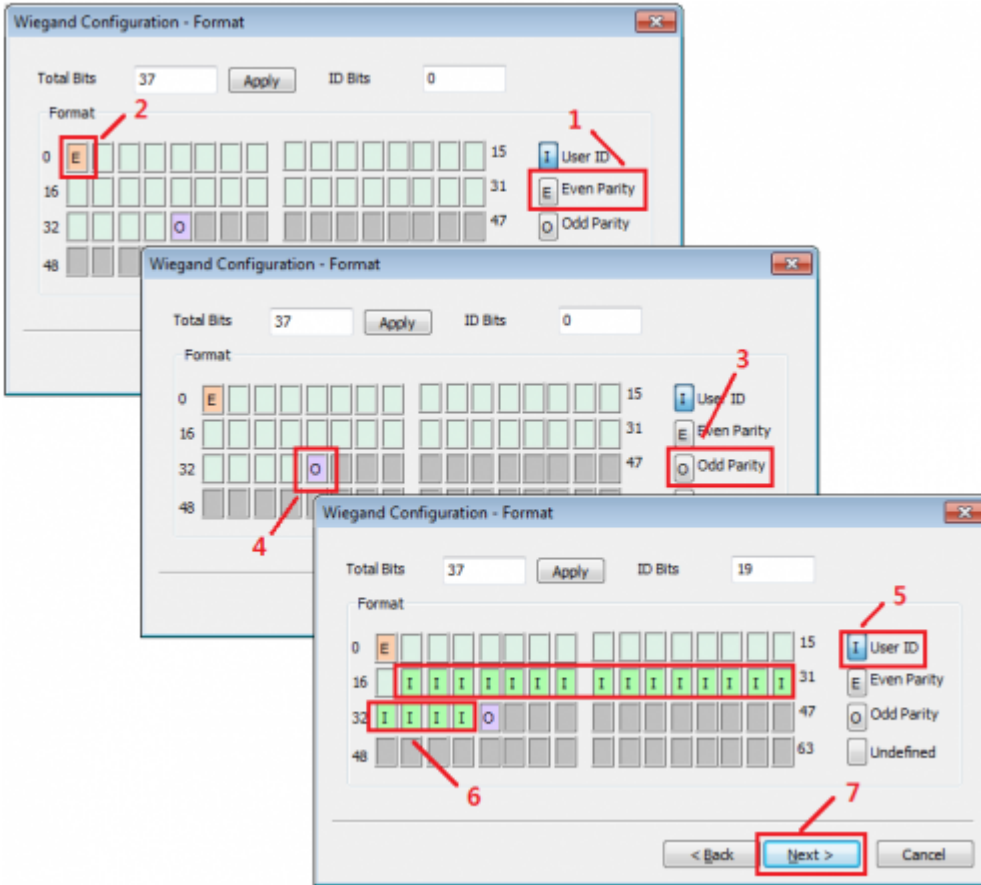

6. Set even parity according to the settings then click »» button to set odd parity.

Number of bits: 37

Number of bits to sum for even parity: 19 (Address to start from: 0)

Number of bits to sum for odd parity: 19 (Address to start from: 18) (Address to end : 37)

Number of Facility Code bits (Undefined): 16 (Address to start from: 1)

Number of Cardholder ID bits: 19 (Address to start from: 17)

Number of Issue Level bits: 0 (Address to start from: 0)

Facility Code: 001

[Figure 10 Wiegand Format Configuration - 6]

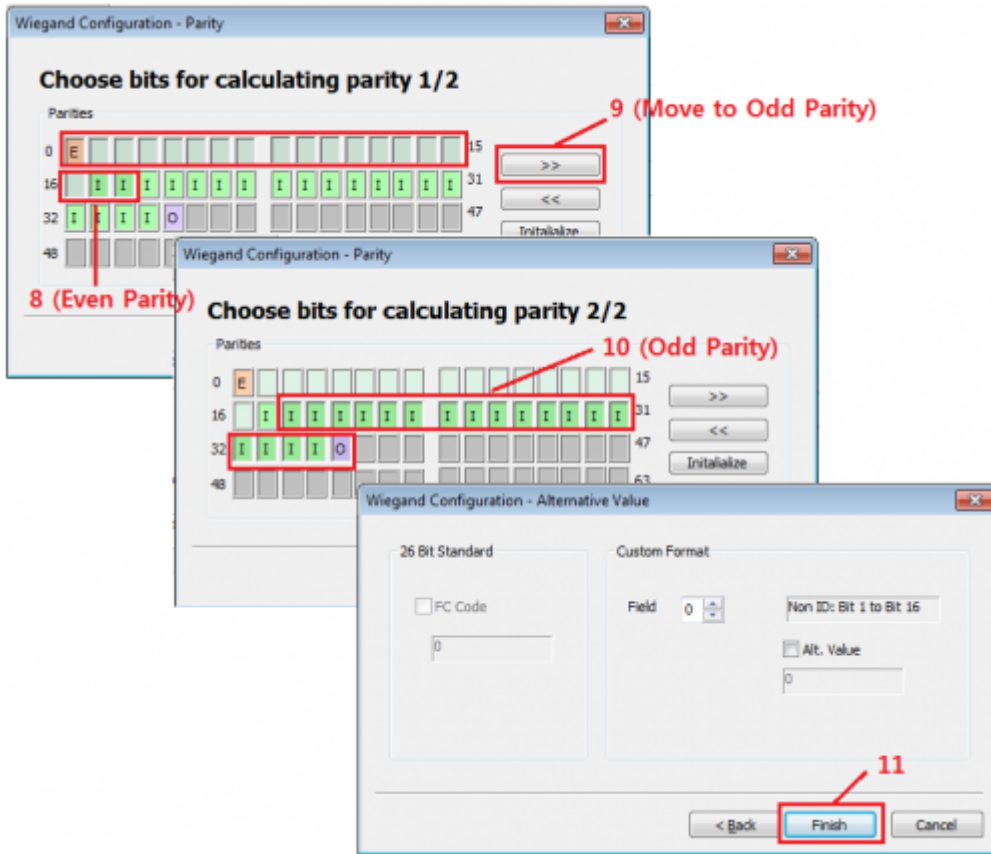

7. Select Wiegand Mode and choose between Wiegand Input and Wiegand Output.

Wiegand Input:

- Wiegand (Card): BioStar receives ID data from Wiegand signal and interprets it as Card ID.
- Wiegand (User): BioStar receives ID data from Wiegand signal and interprets it as User ID.

Wiegand Output:

- Wiegand (Card): BioStar transmits Card ID as Wiegand signal when authentication successes.
- Wiegand (User): BioStar transmits User ID as Wiegand signal when authentication successes.

[Figure 11 Wiegand Mode and Wiegand Input/Output Configuration]

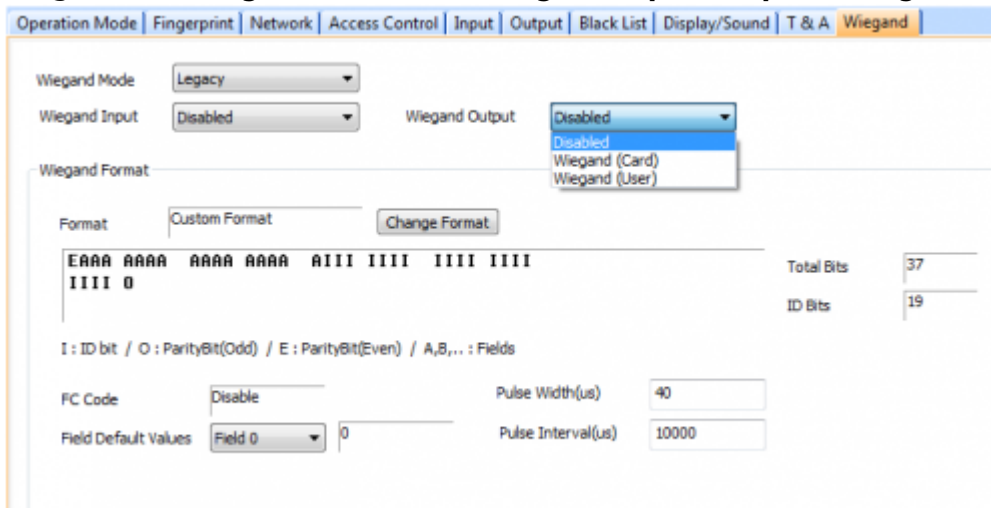

Frequently Asked Questions

(Q) Can we connect HID iClass / HID / Mifare Reader?

(A) Yes, but you must know the Wiegand format of the card or RF reader. Also, we do not support settings for the facility code and supports up to total bit of 64bit and ID bit of 32bit.

(Q) I would like to control doors using Suprema device and RF reader. I have placed card on the RF reader but door won't unlock.

(A) Please check the following:

- Check the Wiegand wiring (Ground - Data 0 - Data 1) and Wiegand format.
 - Check the Wiegand mode. Wiegand mode should be **Wiegand Input (Card)** for this case.
 - Check if the door relay activates when authenticates from Suprema device.
 - Check if the user information is saved in Suprema device.
 - Go to **Monitoring > Realtime Monitoring**.
- When “[1:1 Identify/Verify Fail]” log appears: This log appears when the user information is not saved in the Suprema device or there is difference in Wiegand format. Please check the Wiegand format and send all users to Suprema device again.
 - When no log appears: When there are no logs in the Realtime Monitoring even you placed your card on the RF reader, this means that no Wiegand signals has been transmitted to Suprema device. Please check the Wiegand wiring and Wiegand mode again.

If you need further assistance, please refer an article of [Fresh Desk](#) and contact Suprema TS team.

Summary

Please check the following when connecting Suprema devices with 3rd party Wiegand reader.

Data signaling (electrical) Check the pulse width and intervals of 3rd party Wiegand reader

Pulse width and pulse intervals for Suprema devices

Editable

- BST/BST2/FST/DST: Pulse Width 40 μ s, Pulse interval 10,000 μ s

Editable (only with most recent firmware)

- BEPL/BLN/XPASS: Pulse Width 50 μ s, Pulse interval 2000 μ s

Data Format (numeric content)

- Almost all card data formats are the standard 26 bit format. However, when you need to customize the card data format, you have to configure it correctly to send / receive signals.
- Mifare Card 34 bit format of appendix (1) is helpful. ([Appendix 1. Wiegand 34bit Mifare Card Format Setting Example](#)) Most of the Mifare readers are using this format.
- Wiegand format template of appendix (2) is helpful in summarizing the formats of RF reader. ([Appendix 2. Wiegand Format Template](#))

Appendix 1. Wiegand 34bit Mifare Card Format Setting Example

1. Customize Wiegand format accordingly.

[Figure 12 Mifare Card Format Layout]



2. Most of the Mifare Reader reads card ID byte order in LSB. You can change the byte order to MSB or LSB from below card ID format setting.

[Figure 13 Card ID Format]

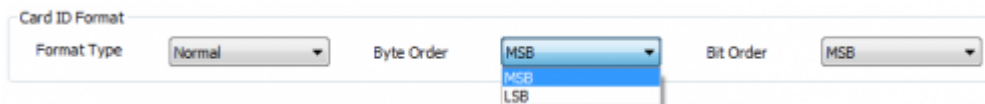

Appendix 2. Wiegand Format Template

For more technical assistance with BioStar Wiegand setting, please refer an article of [Fresh Desk](#) and contact Suprema TS team. Please send us your Wiegand format in below template.

Card Format Name:

Card Type:

Number of bits:

Number of bits to sum for even parity:

Address to start from:

Number of bits to sum for odd parity:

Address to start from:

Number of Facility Code bits:

- Facility Code bits (Undefined / defined):

Address to start from:

Number of Cardholder ID bits:

Address to start from:

Number of Issue Level bits:

Address to start from:

Facility Code:

From:

<https://kb.supremainc.com/knowledge/> -

Permanent link:

https://kb.supremainc.com/knowledge/doku.php?id=en:1xfaq_understanding_wiegand

Last update: **2019/12/30 13:05**